

Datasheet SHT21S

Humidity and Temperature Sensor IC

- Fully calibrated
- SDM interface convertible to analog output
- Low power consumption
- Excellent long term stability
- DFN type package – reflow solderable



Product Summary

SHT21S, the new humidity and temperature sensor of Sensirion is about to set new standards in terms of size and intelligence: Embedded in a reflow solderable Dual Flat No leads (DFN) package of 3 x 3mm foot print and 1.1mm height it provides calibrated, linearized signals in analog Sigma Delta Modulated (SDM) format.

With a completely new designed CMOSens® chip, a reworked capacitive type humidity sensor and an improved band gap temperature sensor the performance level has been lifted even beyond the outstanding reliability level of the previous sensor generation (SHT1x and SHT7x). For example, measures have been taken to stabilize the behavior at high humidity levels.

SDM signal is a pulse sequence that with a low pass filter may be converted into analog voltage output. The data signal is provided on SDA line. Pulling SCL high or low allows for switching between humidity and temperature, respectively. The sensor measures the physical values twice per second.

Every sensor is individually calibrated and tested. Lot identification is printed on the sensor.

With made improvements and the miniaturization of the sensor the performance-to-price ratio has been improved. SHT21 is also available with digital I²C or PWM interface.

Dimensions

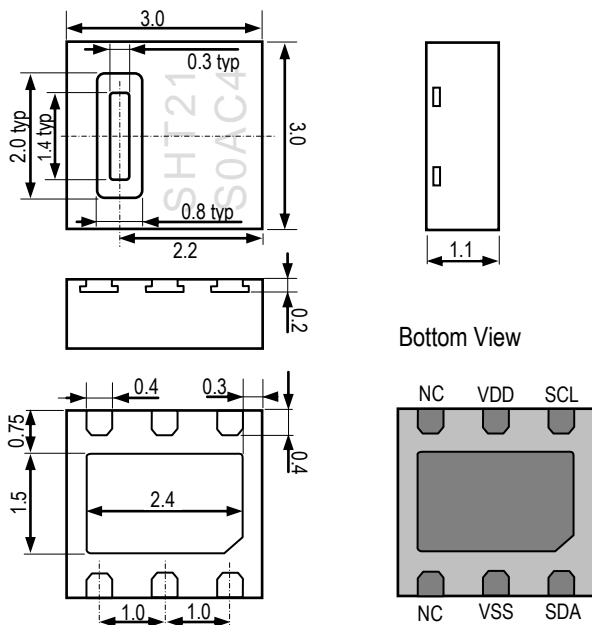

Figure 1: Drawing of SHT21S sensor package, dimensions are given in mm (1mm = 0.039inch), tolerances are ± 0.1 mm. The die pad (center pad) is internally connected to VSS. The NC pads must be left floating. Numbering of E/O pads starts at lower right corner (indicated by notch in die pad) and goes clockwise (compare Table 2).

Sensor Chip

SHT21S feature a generation 4C CMOSens® chip. Besides the capacitive relative humidity sensor and the band gap temperature sensor, the chip contains an amplifier, A/D converter, OTP memory and a digital processing unit.

Material Contents

While the sensor itself is made of Silicon the sensors' housing consists of a plated Cu lead-frame and green epoxy-based mold compound. The device is fully RoHS and WEEE compliant, e.g. free of Pb, Cd and Hg.

Additional Information

Additional information such as Application Notes is available from the web page www.sensirion.com/sht21. For more information please contact Sensirion via info@sensirion.com.

Sensor Performance

Relative Humidity

| Parameter | Condition | min | typ | max | Units |
|---------------------------------|-----------------------|--------------|-------|-----|--------|
| Resolution | 12 bit | | 0.04 | | %RH |
| Accuracy tolerance ¹ | typ | | ±2.0 | | %RH |
| | max | see Figure 2 | | | %RH |
| Repeatability | | | ±0.1 | | %RH |
| Hysteresis | | | ±1 | | %RH |
| Nonlinearity | | | <0.1 | | %RH |
| Response time ² | τ 63% | | 8 | | s |
| Operating Range | extended ³ | 0 | | 100 | %RH |
| Long Term Drift ⁴ | normal | | < 0.5 | | %RH/yr |

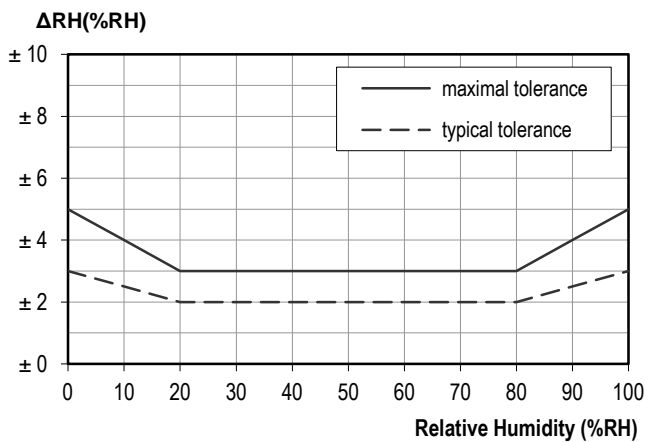

Figure 2 Typical and maximal tolerance at 25°C for relative humidity. For extensive information see Users Guide, Sect. 1.2. For electronic impacts on accuracy please consult Sect. 5.3.

Electrical Specification

| Parameter | Condition | min | typ | max | Units |
|----------------------------------|---------------------------|-----|------|-----|-------|
| Supply Voltage, VDD | | 2.1 | 3.0 | 3.6 | V |
| Supply Current, IDD ⁵ | | | 160 | | μA |
| Power Dissipation ⁵ | | | 0.48 | | mW |
| Measurement Frequency | | | 2 | | Hz |
| Switch RH/T on SDA | SCL up → RH; SCL down → T | | | | |

Table 1 Electrical specification. For absolute maximum values see Chapter 4.1 of Users Guide.

Temperature

| Parameter | Condition | min | typ | max | Units |
|---------------------------------|-----------------------|--------------|--------|-----|-------|
| Resolution | 14 bit | | 0.01 | | °C |
| Accuracy tolerance ¹ | typ | | ±0.3 | | °C |
| | max | see Figure 3 | | | °C |
| Repeatability | | | ±0.1 | | °C |
| Operating Range | extended ³ | -40 | | 125 | °C |
| Response Time ⁶ | τ 63% | 5 | | 30 | s |
| Long Term Drift | | | < 0.04 | | °C/yr |

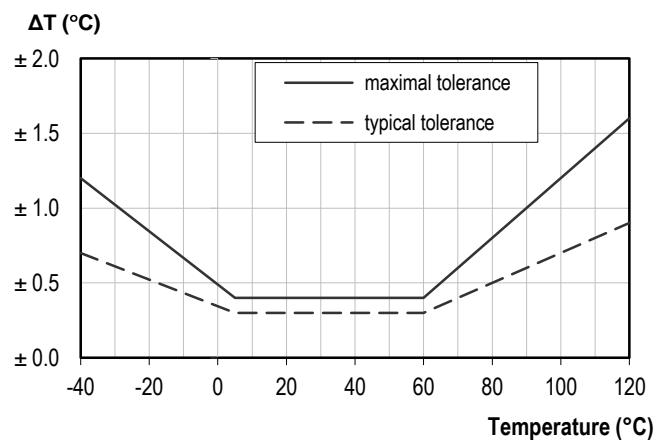

Figure 3 Typical and maximal temperature accuracy tolerance. For electronic impacts on accuracy please consult Sect. 5.3.

Packaging Information

| Sensor Type | Packaging | Quantity | Order Number |
|-------------|-------------|----------|--------------|
| SHT21S | Tape & Reel | 400 | 1-100718-01 |
| | Tape & Reel | 1500 | 1-100697-01 |
| | Tape & Reel | 5000 | 1-100696-01 |

This datasheet is subject to change and may be amended without prior notice.

¹ Accuracies are tested at Outgoing Quality Control at 25°C and 3.0V. Values exclude hysteresis and long term drift and are applicable to non-condensing environments only.

² Time for achieving 63% of a step function, valid at 25°C and 1 m/s airflow.

³ Normal operating range: 0-80%RH, beyond this limit sensor may read a reversible offset with slow kinetics (+3%RH after 60h at humidity >80%RH). For more details please see Section 1.1 of the Users Guide.

⁴ Value may be higher in environments with vaporized solvents, out-gassing tapes, adhesives, packaging materials, etc. For more details please refer to Handling Instructions.

⁵ Values of Supply Current and Power Dissipation are based upon fixed VDD = 3.0V and T = 25°C applying a low pass filter as proposed in Sect. 5.3.

⁶ Response time depends on heat conductivity of sensor substrate.

Users Guide SHT21S

1 Extended Specification

For details on how Sensirion is specifying and testing accuracy performance please consult Application Note “Statement on Sensor Specification”.

1.1 Operating Range

The sensor works stable within recommended Normal Range – see Figure 4. Long term exposure to conditions outside Normal Range, especially at humidity >80%RH, may temporarily offset the RH signal (+3%RH after 60h). After return into the Normal Range it will slowly return towards calibration state by itself. See Section 2.3 “Reconditioning Procedure” for eliminating the offset. Prolonged exposure to extreme conditions may accelerate ageing.

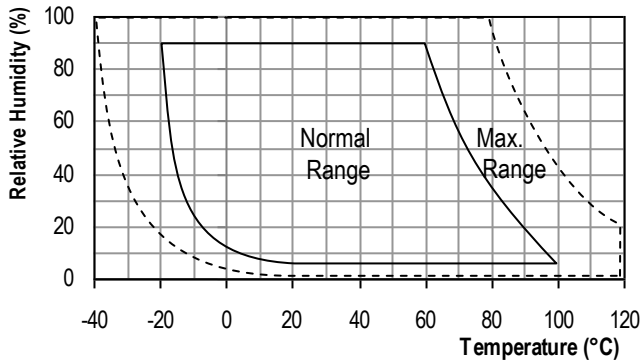

Figure 4 Operating Conditions

1.2 RH accuracy at various temperatures

Maximal tolerance for RH accuracy at 25°C is defined in Figure 2. For other temperatures maximal tolerance has been evaluated to be within limits displayed in Figure 5.

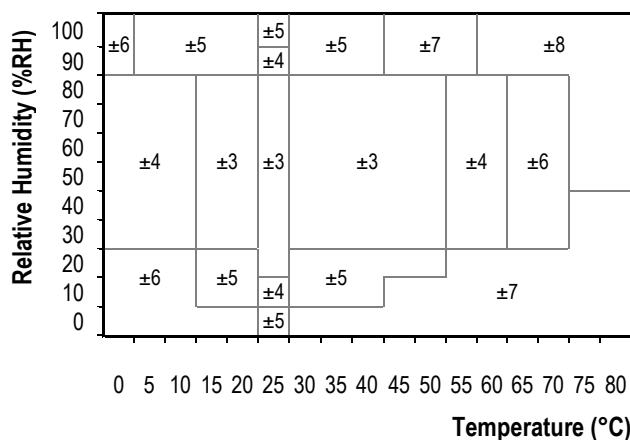

Figure 5 Maximal tolerance of relative humidity measurements given in %RH for temperatures 0 – 80°C.

Please note that above values are maximal tolerances (not including hysteresis) against a high precision reference such as a dew point mirror. Typical deviations are at

±2%RH where maximal tolerance is ±3%RH and about half the maximal tolerance at other values.

2 Application Information

2.1 Soldering Instructions

The DFN's die pad (centre pad) and perimeter I/O pads are fabricated from a planar copper lead-frame by over-molding leaving the die pad and I/O pads exposed for mechanical and electrical connection. Both the I/O pads and die pad should be soldered to the PCB. In order to prevent oxidation and optimize soldering, the bottom side of the sensor pads is plated with Ni/Pd/Au.

On the PCB the I/O lands⁷ should be 0.2mm longer than the package I/O pads. Inward corners may be rounded to match the I/O pad shape. The I/O land width should match the DFN-package I/O-pads width 1:1 and the land for the die pad should match 1:1 with the DFN package – see Figure 6.

The solder mask⁸ design for the land pattern preferably is of type Non-Solder Mask Defined (NSMD) with solder mask openings larger than metal pads. For NSMD pads, the solder mask opening should be about 120µm to 150µm larger than the pad size, providing a 60µm to 75µm design clearance between the copper pad and solder mask. Rounded portions of package pads should have a matching rounded solder mask-opening shape to minimize the risk of solder bridging. For the actual pad dimensions, each pad on the PCB should have its own solder mask opening with a web of solder mask between adjacent pads.

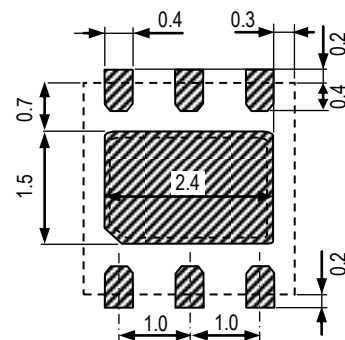

Figure 6 Recommended metal land pattern for SHT2x. Values in mm. Die pad (centre pad) may be left floating or be connected to ground, NC pads shall be left floating. The outer dotted line represents the outer dimension of the DFN package.

⁷ The land pattern is understood to be the metal layer on the PCB, onto which the DFN pads are soldered to.

⁸ The solder mask is understood to be the insulating layer on top of the PCB covering the connecting lines.

For *solder paste printing* a laser-cut, stainless steel stencil with electro-polished trapezoidal walls and with 0.125mm stencil thickness is recommended. For the I/O pads the stencil apertures should be 0.1mm longer than PCB pads and positioned with 0.1mm offset away from the centre of the package. The die pad aperture should cover about 70 – 90% of the pad area – say up to 1.4mm x 2.3mm centered on the thermal land area. It can also be split in two openings.

Due to the low mounted height of the DFN, “no clean” type 3 solder paste⁹ is recommended as well as Nitrogen purge during reflow.

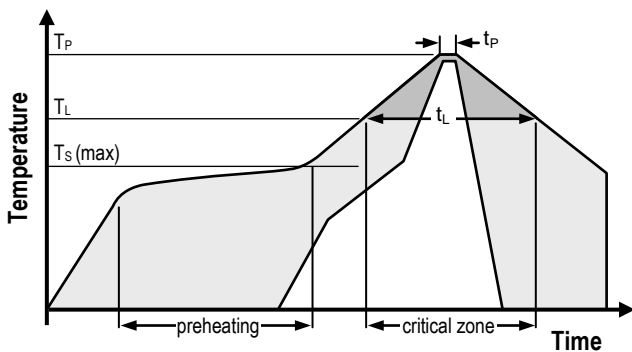

Figure 7 Soldering profile according to JEDEC standard. $T_P \leq 260^\circ\text{C}$ and $t_P < 30\text{sec}$ for Pb-free assembly. $T_L < 220^\circ\text{C}$ and $t_L < 150\text{sec}$. Ramp-up/down speeds shall be $< 5^\circ\text{C}/\text{sec}$.

It is important to note that the diced edge or side faces of the I/O pads may oxidise over time, therefore a solder fillet may or may not form. Hence there is no guarantee for solder joint fillet heights of any kind.

For soldering SHT2x, standard *reflow soldering* ovens may be used. The sensor is qualified to withstand soldering profile according to IPC/JEDEC J-STD-020 with peak temperatures at 260°C during up to 30sec for Pb-free assembly in IR/Convection reflow ovens (see Figure 7).

For manual soldering contact time must be limited to 5 seconds at up to 350°C .

IMPORTANT: After soldering, the devices should be stored at $>75\%RH$ for at least 12h to allow the sensor element to re-hydrate. Otherwise the sensor may read an offset that slowly disappears if exposed to ambient conditions. Alternatively the re-hydration process may be performed at ambient conditions ($>40\%RH$) during more than 5 days.

In no case, neither after manual nor reflow soldering, a board wash shall be applied. Therefore, and as mentioned above, it is strongly recommended to use “no-clean” solder paste. In case of applications with exposure of the sensor to corrosive gases or condensed water (i.e. environments with high relative humidity) the soldering pads shall be

sealed (e.g. conformal coating) to prevent loose contacts or short cuts.

2.2 Storage Conditions and Handling Instructions

Moisture Sensitivity Level (MSL) is 1, according to IPC/JEDEC J-STD-020. At the same time, it is recommended to further process the sensors within 1 year after date of delivery.

It is of great importance to understand that a humidity sensor is not a normal electronic component and needs to be handled with care. Chemical vapors at high concentration in combination with long exposure times may offset the sensor reading.

For this reason it is recommended to store the sensors in original packaging including the sealed ESD bag at following conditions: Temperature shall be in the range of $10^\circ\text{C} - 50^\circ\text{C}$ and humidity at $20 - 60\%RH$ (sensors that are not stored in ESD bags). For sensors that have been removed from the original packaging we recommend to store them in ESD bags made of metal-in PE-HD¹⁰.

In manufacturing and transport the sensors shall be prevented of high concentration of chemical solvents and long exposure times. Out-gassing of glues, adhesive tapes and stickers or out-gassing packaging material such as bubble foils, foams, etc. shall be avoided. Manufacturing area shall be well ventilated.

For more detailed information please consult the document “*Handling Instructions*” or contact Sensirion.

2.3 Reconditioning Procedure

As stated above extreme conditions or exposure to solvent vapors may offset the sensor. The following reconditioning procedure may bring the sensor back to calibration state:

Baking: $100 - 105^\circ\text{C}$ at $< 5\%RH$ for 10h
 Re-Hydration: $20 - 30^\circ\text{C}$ at $\sim 75\%RH$ for 12h¹¹.

2.4 Temperature Effects

Relative humidity reading strongly depends on temperature. Therefore, it is essential to keep humidity sensors at the same temperature as the air of which the relative humidity is to be measured. In case of testing or qualification the reference sensor and test sensor must show equal temperature to allow for comparing humidity readings.

If the sensor shares a PCB with electronic components that produce heat it should be mounted in a way that prevents heat transfer or keeps it as low as possible. Measures to reduce heat transfer can be ventilation, reduction of copper layers between the sensor and the

⁹ Solder types are related to the solder particle size in the paste: Type 3 covers the size range of $25 - 45 \mu\text{m}$ (powder type 42).

¹⁰ For example, 3M antistatic bag, product “1910” with zipper.

¹¹ $75\%RH$ can conveniently be generated with saturated NaCl solution.

rest of the PCB or milling a slit into the PCB around the sensor – see Figure 8.

Due to the possible high frequency output the sensor may heat up if long cables are applied. Therefore, a low pass filter shall be placed close to the sensor. Please compare Section 5.3 for further information.

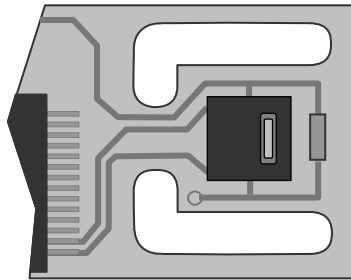

Figure 8 Top view of example of mounted SHT2x with slits milled into PCB to minimize heat transfer.

2.5 Light

The SHT2x is not light sensitive. Prolonged direct exposure to sunshine or strong UV radiation may age the sensor.

2.6 Materials Used for Sealing / Mounting

Many materials absorb humidity and will act as a buffer increasing response times and hysteresis. Materials in the vicinity of the sensor must therefore be carefully chosen. Recommended materials are: Any metals, LCP, POM (Delrin), PTFE (Teflon), PEEK, PP, PB, PPS, PSU, PVDF, PVF.

For sealing and gluing (use sparingly): Use high filled epoxy for electronic packaging (e.g. glob top, underfill), and Silicone. Out-gassing of these materials may also contaminate the sensor (see Section 2.2). Therefore try to add the sensor as a last manufacturing step to the assembly, store the assembly well ventilated after manufacturing or bake at >50°C for 24h to outgas contaminants before packing.

3 Interface Specifications

| Pin | Name | Comment |
|-----|------|----------------------|
| 1 | SDA | Data bit-stream |
| 2 | VSS | Ground |
| 5 | VDD | Supply Voltage |
| 6 | SCL | Selector for RH or T |
| 3,4 | NC | Not connected |

Table 2 SHT21S pin assignment (top view)

3.1 Power Pins (VDD, VSS)

The supply voltage of SHT21S must be in the range of 2.1 – 3.6V, recommended supply voltage is 3.0V. Power supply pins Supply Voltage (VDD) and Ground (VSS) must be decoupled with a 100nF capacitor, that shall be placed as close to the sensor as possible – see Figure 9.

3.2 SCL – Output Selector Pad

SCL is used to select humidity or temperature output. SCL high yields humidity output, SCL low yields temperature output.

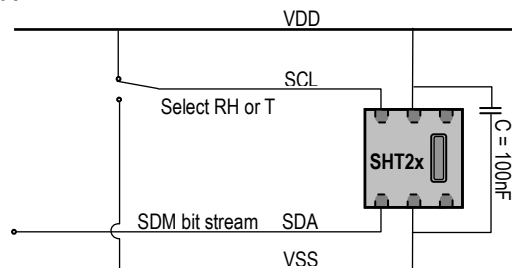

Figure 9 Typical application circuit, including decoupling of VDD and VSS by a capacitor.

3.3 SDA – Bit Stream Pad

On SDA the sensor is providing SDM output. The signal is carrying humidity or temperature data depending on SCL being high or low, respectively. See Table 4 for detailed I/O characteristic of the sensor.

4 Electrical Characteristics

4.1 Absolute Maximum Ratings

The electrical characteristics of SHT21S are defined in Table 1. The absolute maximum ratings as given in Table 3 are stress ratings only and give additional information. Functional operation of the device at these conditions is not implied. Exposure to absolute maximum rating conditions for extended periods may affect the sensor reliability (e.g. hot carrier degradation, oxide breakdown).

| Parameter | min | max | Units |
|------------------------------------|------|-----------|-------|
| VDD to VSS | -0.3 | 5 | V |
| Digital I/O Pins (SDA, SCL) to VSS | -0.3 | VDD + 0.3 | V |
| Input Current on any Pin | -100 | 100 | mA |

Table 3 Electrical absolute maximum ratings

ESD immunity is qualified according to JEDEC JESD22-A114 method (Human Body Model at $\pm 4\text{kV}$), JEDEC JESD22-A115 method (Machine Model $\pm 200\text{V}$) and ESDA ESD-STM5.3.1-1999 and AEC-Q100-011 (Charged Device Model, 750V corner pins, 500V other pins). Latch-up immunity is provided at a force current of $\pm 100\text{mA}$ with $T_{\text{amb}} = 125^\circ\text{C}$ according to JEDEC JESD78. For exposure beyond named limits the sensor needs additional protection circuit.

4.2 Input / Output Characteristics

The electrical characteristics such as power consumption, low and high level input and output voltages depend on the supply voltage. For proper communication with the sensor it is essential to make sure that signal design is strictly within the limits given in Table 4.

| Parameter | min | typ | max | Units |
|--------------------------|-----|-----|-----|---------------|
| Output Low Voltage, VOL | | 0 | | V |
| Output High Voltage, VOH | | VDD | | V |
| Output Sink Current, IOL | | | 40 | μA |

Table 4 DC characteristics of input / output pad. VDD = 2.1 V to 3.6 V, T = -40°C to 125°C , unless otherwise noted.

5 Communication with Sensor

5.1 Start up Sensor

As a first step, the sensor is powered up to the chosen supply voltage VDD (between 2.1V and 3.6V). After power-up, the sensor needs at most 150ms for reaching idle state. During that time SDA is in undefined state. Then the sensor starts measuring and providing data on SDM bit-stream.

5.2 SDM Output Principle

Sigma Delta Modulation is a bit-stream of pulses; the more high pulses the higher the value in the full measurement range – see Figure 10. Such information is humidity for SCL pulled high and temperature for SCL pulled low. The fundamental frequency of SDM is in the range of roughly 4 kHz and 65 kHz.

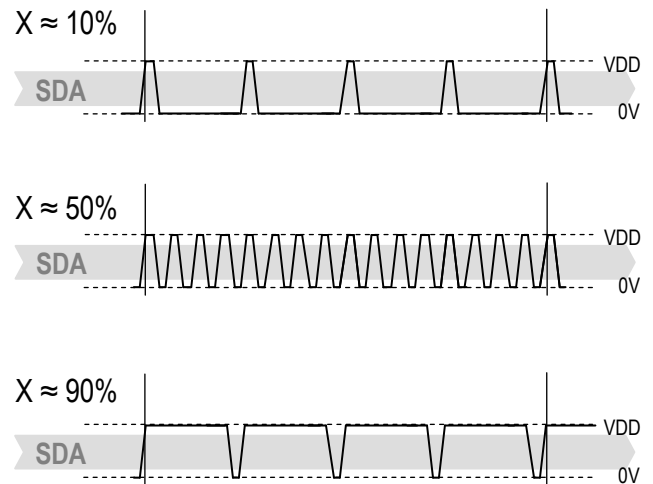

Figure 10 Schematic principle of SDM signal. X represents either RH or T at different levels of sensor output.

5.3 Converting SDM to Analog Signal

An SDM signal normally is converted to an analog voltage signal by the addition of a low-pass filter. Figure 11 displays a typical circuit where a simple RC-filter is used. For conversion into physical values please read the following Chapter.

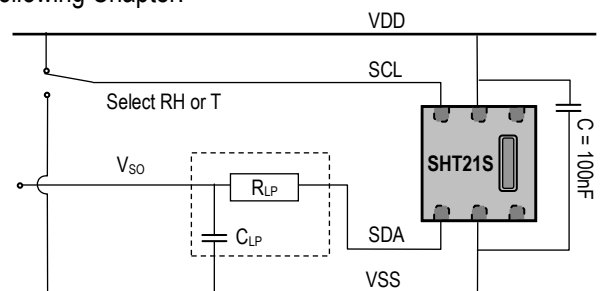

Figure 11 Typical circuit with low pass filter (surrounded by hatched line) for analog output. Recommended component size: $R_{LP} = 100\text{k}\Omega$ and $C_{LP} = 220\text{nF}$. By pulling SCL low or high, the output value is switched to temperature or humidity, respectively.

For an acceptable small ripple of the analog voltage signal, a cut-off frequency of 7Hz is recommended. Typical values for the low pass filter components are $R = 100\text{k}\Omega$ and $C = 220\text{nF}$. The corresponding ripple of the signal is limited to maximal amplitude of $\pm 0.2\%RH$ and $\pm 0.28^\circ\text{C}$, respectively. If larger deviations are acceptable the capacitor size can be reduced.

Important: The maximum current from SDA should not exceed $40\mu\text{A}$. Therefore, there are restrictions on the size of the resistance R_{LP} . Furthermore, the current should be kept as low as possible and therefore the input impedance of the reading buffer shall be larger than $50\text{M}\Omega$ (60nA input biased current). Eventually, cable length between sensor and low pass filter shall be kept as short as possible in order to prevent self heating.

Please note, that ripples and impacts by impedance are not considered in the accuracy statement.

6 Conversion of Signal Output

After the low pass filter the sensor provides an output Voltage V_{SO} which as a portion of V_{DD} then is converted into a physical value.

Resolution is set to 10 bit for relative humidity and 12 bit for temperature and cannot be changed. The sensor reading is linearized and hence it can be converted to a physical value by an easy linear equation.

6.1 Relative Humidity Conversion

With the relative humidity signal output the relative humidity RH is obtained by the following formula (result in %RH):

$$RH = -6 + 125 \cdot \frac{V_{SO}}{V_{DD}}$$

The physical value RH given above corresponds to the relative humidity above liquid water according to World Meteorological Organization (WMO). For relative humidity above ice RH_i the values need to be transformed from relative humidity above water RH_w at a certain temperature t . The equation is given in the following, compare also Application Note "Introduction to Humidity":

$$RH_i = RH_w \cdot \exp\left(\frac{\beta_w \cdot t}{\lambda_w + t}\right) / \exp\left(\frac{\beta_i \cdot t}{\lambda_i + t}\right)$$

Units are %RH for relative humidity and °C for temperature. The corresponding coefficients are defined as follows: $\beta_w = 17.62$, $\lambda_w = 243.12^\circ\text{C}$, $\beta_i = 22.46$, $\lambda_i = 272.62^\circ\text{C}$.

6.2 Temperature Conversion

The temperature T is calculated by inserting temperature signal output S_T into the following formula (result in °C):

$$T = -46.85 + 175.72 \cdot \frac{V_{SO}}{V_{DD}}$$

7 Environmental Stability

The SHT2x sensor series were tested based on AEC-Q100 Rev. G qualification test method where applicable. Sensor specifications are tested to prevail under the AEC-Q100 temperature grade 2 test conditions listed in Table 5¹².

Sensor performance under other test conditions cannot be guaranteed and is not part of the sensor specifications. Especially, no guarantee can be given for sensor

performance in the field or for customer's specific application.

| Environment | Standard | Results ¹³ |
|--------------|---|-----------------------|
| HTOL | 125°C, 408 hours | Within specifications |
| TC | -50°C - 125°C, 1000 cycles | Within specifications |
| UHST | 130°C / 85%RH / ≈2.3bar, 96h | Within specifications |
| THB | 85°C / 85%RH, 1000h | Within specifications |
| ESD immunity | HBM ±4kV, MM ±200V, CDM 750V/500V (corner/other pins) | Qualified |
| Latch-up | force current of ±100mA with $T_{amb} = 80^\circ\text{C}$ | Qualified |

Table 5: Qualification tests: HTOL = High Temperature Operating Lifetime, TC = Temperature Cycles, UHST = Unbiased Highly accelerated Stress Test, THB = Temperature Humidity Biased. For details on ESD see Sect. 4.1.

If sensors are qualified for reliability and behavior in extreme conditions, please make sure that they experience same conditions as the reference sensor. It should be taken into account that response times in assemblies may be longer, hence enough dwell time for the measurement shall be granted. For detailed information please consult Application Note "Qualification Guide".

8 Packaging

8.1 Packaging type

SHT2x sensors are provided in DFN packaging (in analogy with QFN packaging). DFN stands for Dual Flat No leads.

The sensor chip is mounted to a lead frame made of Cu and plated with Ni/Pd/Au. Chip and lead frame are over molded by green epoxy-based mold compound. Please note that side walls of sensors are diced and hence lead frame at diced edge is not covered with respective protective coating. The total weight of the sensor is 25mg.

8.2 Filter Cap and Sockets

For SHT2x a filter cap SF2 is available. It is designed for fast response times and compact size. Please find the datasheet on Sensirion's web page.

For testing of SHT2x sensors sockets, such as from Plastronics, part number 10LQ50S13030 are recommended (see e.g. www.locknest.com).

¹² Sensor operation temperature range is -40 to 105°C according to AEC-Q100 temperature grade 2.

¹³ According to accuracy and long term drift specification given on Page 2.

8.3 Traceability Information

All SHT2x are laser marked with an alphanumeric, five-digit code on the sensor – see Figure 12.



Figure 12 Laser marking on sensor. For details see text.

The marking on the sensor consists of two lines with five digits each. The first line denotes the sensor type (SHT21). The first digit of the second line defines the output mode (D = digital, Sensibus and I2C, P = PWM, S = SDM). The second digit defines the manufacturing year (0 = 2010, 1 = 2011, etc.). The last three digits represent an alphanumeric tracking code. That code can be decoded by Sensirion only and allows for tracking on batch level through production, calibration and testing – and will be provided upon justified request.

Reels are also labeled, as displayed in Figure 13 and Figure 14, and give additional traceability information.

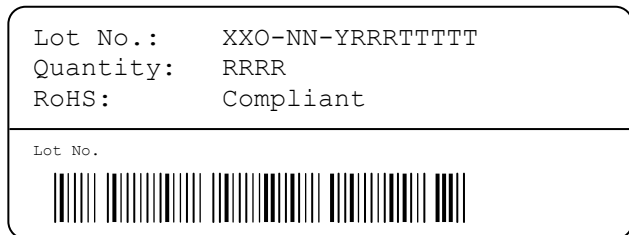

Figure 13: First label on reel: XX = Sensor Type (21 for SHT21), O = Output mode (D = Digital, P = PWM, S = SDM), NN = product revision no., Y = last digit of year, RRR = number of sensors on reel divided by 10 (200 for 2000 units), TTTTT = Traceability Code.

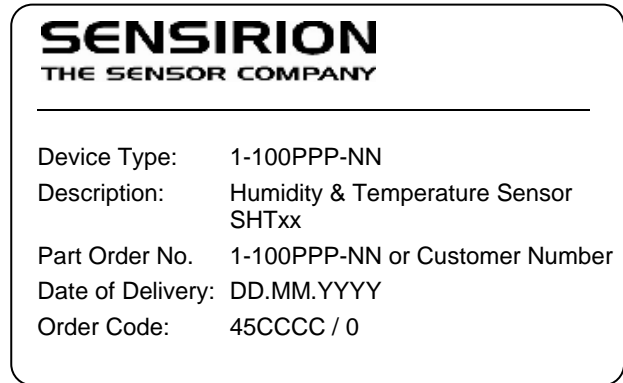

Figure 14: Second label on reel: For Device Type and Part Order Number (See Packaging Information on page 2), Delivery Date (also Date Code) is date of packaging of sensors (DD = day, MM = month, YYYY = year), CCCC = Sensirion order number.

8.4 Shipping Package

SHT2x are provided in tape & reel shipment packaging, sealed into antistatic ESD bags. For SHT21S standard packaging sizes are 400, 1500 and 5000 units per reel. Each reel contains 440mm (55 pockets) header tape and 200mm (25 pockets) trailer tape.

The drawing of the packaging tapes with sensor orientation is shown in Figure 15. The reels are provided in sealed antistatic bags.

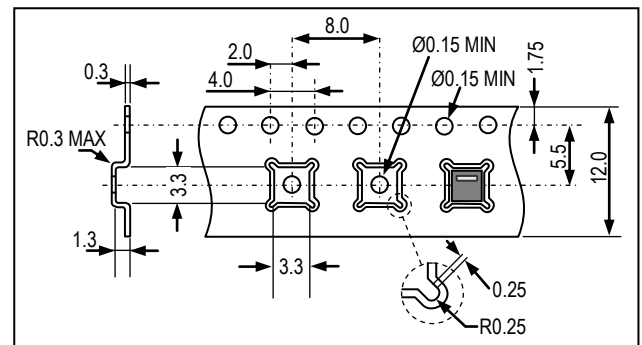

Figure 15 Sketch of packaging tape and sensor orientation. Header tape is to the right and trailer tape to the left on this sketch.

Revision History

| Date | Version | Page(s) | Changes |
|---------------|---------|------------------|--|
| 19 Aug 2009 | 0.6 | 1, 7 | Figure 1, add details to Chapter 7, add coefficients to Tables 5, 6. |
| 4 March 2010 | 1.0 | 1 – 9 | Completely revised version. Require Change Protocol for details. |
| 5 May 2010 | 1.1 | 1 – 9 | Elimination of errors and addition of information (ask for change protocol) |
| 27 April 2011 | 2 | 1 – 4, 6 – 10 | Updated temperature accuracy specifications, MSL and standards. Elimination of errors. For detailed information, please require complete change list at info@sensirion.com . |
| December 2011 | 3 | 1, 7 | Minor text adaptations and corrections. |

Warning, Personal Injury

Important Notices

Do not use this product as safety or emergency stop devices or in any other application where failure of the product could result in personal injury. Do not use this product for applications other than its intended and authorized use. Before installing, handling, using or servicing this product, please consult the data sheet and application notes. Failure to comply with these instructions could result in death or serious injury.

If the Buyer shall purchase or use SENSIRION products for any unintended or unauthorized application, Buyer shall defend, indemnify and hold harmless SENSIRION and its officers, employees, subsidiaries, affiliates and distributors against all claims, costs, damages and expenses, and reasonable attorney fees arising out of, directly or indirectly, any claim of personal injury or death associated with such unintended or unauthorized use, even if SENSIRION shall be allegedly negligent with respect to the design or the manufacture of the product.

ESD Precautions

The inherent design of this component causes it to be sensitive to electrostatic discharge (ESD). To prevent ESD-induced damage and/or degradation, take customary and statutory ESD precautions when handling this product.

See application note "ESD, Latchup and EMC" for more information.

Warranty

SENSIRION warrants solely to the original purchaser of this product for a period of 12 months (one year) from the date of delivery that this product shall be of the quality, material and workmanship defined in SENSIRION's published specifications of the product. Within such period, if proven to be defective, SENSIRION shall repair and/or replace this product, in SENSIRION's discretion, free of charge to the Buyer, provided that:

- notice in writing describing the defects shall be given to SENSIRION within fourteen (14) days after their appearance;

- such defects shall be found, to SENSIRION's reasonable satisfaction, to have arisen from SENSIRION's faulty design, material, or workmanship;
- the defective product shall be returned to SENSIRION's factory at the Buyer's expense; and
- the warranty period for any repaired or replaced product shall be limited to the unexpired portion of the original period.

This warranty does not apply to any equipment which has not been installed and used within the specifications recommended by SENSIRION for the intended and proper use of the equipment. EXCEPT FOR THE WARRANTIES EXPRESSLY SET FORTH HEREIN, SENSIRION MAKES NO WARRANTIES, EITHER EXPRESS OR IMPLIED, WITH RESPECT TO THE PRODUCT. ANY AND ALL WARRANTIES, INCLUDING WITHOUT LIMITATION, WARRANTIES OF MERCHANTABILITY OR FITNESS FOR A PARTICULAR PURPOSE, ARE EXPRESSLY EXCLUDED AND DECLINED.

SENSIRION is only liable for defects of this product arising under the conditions of operation provided for in the data sheet and proper use of the goods. SENSIRION explicitly disclaims all warranties, express or implied, for any period during which the goods are operated or stored not in accordance with the technical specifications.

SENSIRION does not assume any liability arising out of any application or use of any product or circuit and specifically disclaims any and all liability, including without limitation consequential or incidental damages. All operating parameters, including without limitation recommended parameters, must be validated for each customer's applications by customer's technical experts. Recommended parameters can and do vary in different applications.

SENSIRION reserves the right, without further notice, (i) to change the product specifications and/or the information in this document and (ii) to improve reliability, functions and design of this product.

Copyright© 2011, SENSIRION.
CMOSens® is a trademark of Sensirion
All rights reserved

Headquarters and Subsidiaries

SENSIRION AG
Laubisruetistr. 50
CH-8712 Staefa ZH
Switzerland

phone: +41 44 306 40 00
fax: +41 44 306 40 30
info@sensirion.com
www.sensirion.com

Sensirion AG (Germany)
phone: +41 44 927 11 66
info@sensirion.com
www.sensirion.com

Sensirion Inc., USA
phone: +1 805 409 4900
info_us@sensirion.com
www.sensirion.com

Sensirion Japan Co. Ltd.
phone: +81 3 3444 4940
info@sensirion.co.jp
www.sensirion.co.jp

Sensirion Korea Co. Ltd.
phone: +82 31 345 0031 3
info@sensirion.co.kr
www.sensirion.co.kr

Sensirion China Co. Ltd.
phone: +86 755 8252 1501
info@sensirion.com.cn
www.sensirion.com.cn

To find your local representative, please visit www.sensirion.com/contact